

CMG-CMGX ~ 2900 rpm

Centrifugal Flanged
EN 733



Monobloc horizontal centrifugal pumps, constructed in compliance with EN 733 standards, with stub-shaft and bracket for coupling to standard motors; widely used in water supplies, pressurisation and fire-fighting systems; standard supply with counter-flange.

Construction features	
Pump body	cast iron (CMG) stainless steel AISI 316 (CMGX)
Motor bracket	cast iron
Impeller	cast iron, bronze, steel (CMG), steel (CMGX)
Seal type	mechanical
Pump shaft end	stainless steel AISI 316
Liquid temperature	-10 ÷ +90 °C
Operating pressure	max 10 bar

Motor	
2 poles induction motor	3~ 400/690V - 50Hz
Insulation class	F
Protection degree	IPX5

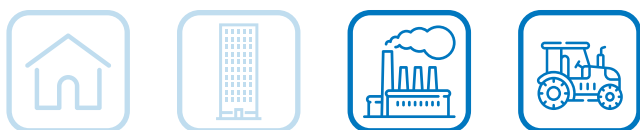
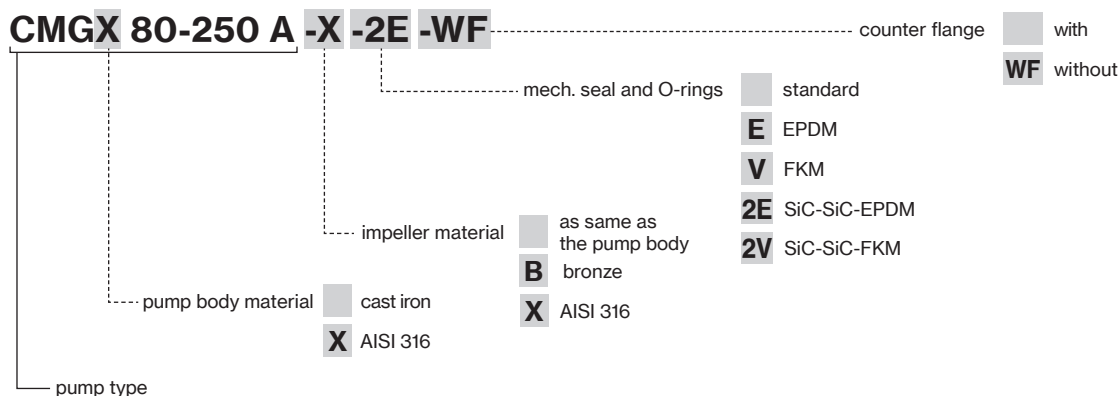

CM-CMG-CA-4CA

Centrifugal Flanged
EN 733

CM: Front suction close-coupled centrifugal pumps with close impeller mounted on IE3 motor shaft extension. Pump casing with axial suction and radial delivery on top, main dimensions and performance according to EN 733.

CMG-CMGX: Front suction centrifugal pumps connected to IE3 standard motor (stub-shaft construction). Pump casing with axial suction and radial delivery on top, main dimensions and performance according to EN 733.

CA-CAX-4CA-4CAX: Single-stage end-suction centrifugal frame-mounted pumps. Dimensions in accordance with EN 733.

TYPE	2 POLES							4 POLES			
	CM	CMG	CMGX	CA	CAT CAX CATX	Flow rate	Head	4CA 4CAT	4CAX 4CATX	Flow rate	Head
						m ³ /h	m			m ³ /h	m
32-160C	■	-	-	■	■	6 ÷ 21	22,8 ÷ 14	■	■	1,5 ÷ 12	5,9 ÷ 2,6
32-160B	■	-	-	■	■	6 ÷ 24	27,7 ÷ 17	■	■	1,5 ÷ 12	7,2 ÷ 3,6
32-160A	■	-	-	■	■	6 ÷ 27	36,2 ÷ 22,1	■	■	1,5 ÷ 15	8,8 ÷ 4
32-200C	■	-	-	■	■	6 ÷ 27	40,3 ÷ 28,7	■	■	3 ÷ 18	10,8 ÷ 4,2
32-200B1	■	-	-	-	-	6 ÷ 27	48 ÷ 37,9	-	-	-	-
32-200B	■	-	-	■	■	6 ÷ 30	48 ÷ 35,4	■	■	3 ÷ 18	12,7 ÷ 6,3
32-200A1	■	-	-	-	-	6 ÷ 30	58,3 ÷ 46,6	-	-	-	-
32-200A	■	-	-	■	■	6 ÷ 33	58,3 ÷ 44,3	■	■	3 ÷ 21	15,7 ÷ 6,8
32-250C	■	-	-	■	■	6 ÷ 27	72 ÷ 61,3	■	■	3 ÷ 21	17,2 ÷ 6,5
32-250B	■	-	-	■	■	7,5 ÷ 27	84 ÷ 73,2	■	■	3 ÷ 21	20 ÷ 8,3
32-250A1	■	-	-	-	-	7,5 ÷ 27	93,6 ÷ 85,3	-	-	-	-
32-250A	■	-	-	■	■	7,5 ÷ 27	93,6 ÷ 85,5	■	■	3 ÷ 21	22,2 ÷ 9,1
40-125C	■	-	-	■	■	9 ÷ 36	18,5 ÷ 9,4	■	■	4,5 ÷ 21	4,4 ÷ 2
40-125B	■	-	-	■	■	9 ÷ 39	23,4 ÷ 13,2	■	■	4,5 ÷ 21	5,5 ÷ 3,3
40-125A	■	-	-	■	■	9 ÷ 42	27,6 ÷ 16,8	■	■	4,5 ÷ 24	6,3 ÷ 3,4
40-160B	■	-	-	■	■	9 ÷ 36	29,2 ÷ 20,5	■	■	4,5 ÷ 24	7,5 ÷ 2,5
40-160A	■	-	-	■	■	9 ÷ 42	34,9 ÷ 23,4	■	■	4,5 ÷ 24	8,9 ÷ 4,5
40-160AP	■	-	-	■	■	9 ÷ 48	39,8 ÷ 25,3	■	■	4,5 ÷ 24	11,1 ÷ 6,8
40-200B1	■	-	-	-	-	9 ÷ 39	45,5 ÷ 32,3	-	-	-	-
40-200B	■	-	-	■	■	9 ÷ 42	45,5 ÷ 29,4	■	■	6 ÷ 24	11,4 ÷ 4,7
40-200A1	■	-	-	-	-	9 ÷ 39	56,5 ÷ 44,4	-	-	-	-
40-200A	■	-	-	■	■	9 ÷ 42	56,5 ÷ 41,6	■	■	6 ÷ 24	13,9 ÷ 8,3
40-200AP	■	-	-	■	■	9 ÷ 45	61,4 ÷ 42,2	■	■	6 ÷ 24	14,9 ÷ 9,4
40-250C	■	-	-	■	■	9 ÷ 36	64,4 ÷ 55,4	■	■	9 ÷ 27	15,2 ÷ 6,6
40-250B	■	-	-	■	■	9 ÷ 39	79,9 ÷ 62,1	■	■	9 ÷ 30	18,2 ÷ 8,3
40-250A1	■	-	-	-	-	9 ÷ 42	84,6 ÷ 72,8	-	-	-	-
40-250A	■	-	-	■	■	9 ÷ 45	84,6 ÷ 69	■	■	9 ÷ 33	20,8 ÷ 8,4
40-250BM	■	-	-	■	■	9 ÷ 54	93,2 ÷ 72	-	-	-	-
40-250AM	■	-	-	■	■	9 ÷ 60	103 ÷ 77,5	-	-	-	-
50-125B	■	-	-	■	■	12 ÷ 72	20,6 ÷ 9,2	■	■	9 ÷ 42	5,5 ÷ 2,1
50-125A	■	-	-	■	■	12 ÷ 72	24,3 ÷ 14,2	■	■	9 ÷ 45	6,4 ÷ 2,9
50-160B1	■	-	-	-	-	21 ÷ 66	33,5 ÷ 21,5	-	-	-	-
50-160B	■	-	-	■	■	21 ÷ 72	33,5 ÷ 18,9	■	■	9 ÷ 42	8 ÷ 2,3
50-160A1	■	-	-	-	-	21 ÷ 72	39,8 ÷ 27,6	-	-	-	-
50-160A	■	-	-	■	■	21 ÷ 78	39,8 ÷ 25,4	■	■	9 ÷ 48	9,4 ÷ 3,1
50-200C	■	-	-	■	■	24 ÷ 72	49,7 ÷ 28,9	■	■	9 ÷ 39	12 ÷ 3,2
50-200B	■	-	-	■	■	24 ÷ 72	54,6 ÷ 35	■	■	10,5 ÷ 42	13,1 ÷ 4,2
50-200A1	■	-	-	-	-	24 ÷ 78	61,8 ÷ 39,8	-	-	-	-



TYPE	2 POLES							4 POLES			
	CM	CMG	CMGX	CA	CAT CAX CATX	Flow rate	Head	4CA 4CAT	4CAX 4CATX	Flow rate	Head
						m³/h	m			m³/h	m
50-200A	■	-	-	■	■	24 ÷ 78	61,8 ÷ 39,8	■	■	10,5 ÷ 45	14,7 ÷ 4,6
50-250C1	■	-	-	-	-	27 ÷ 60	68,2 ÷ 56,2	-	-	-	-
50-250C	■	-	-	■	■	27 ÷ 66	68,2 ÷ 52,1	■	■	12 ÷ 45	17,7 ÷ 7,5
50-250B	■	-	-	■	■	27 ÷ 72	78,4 ÷ 58,5	■	■	12 ÷ 48	20 ÷ 8,2
50-250A	■	-	-	■	■	27 ÷ 78	88,3 ÷ 61,8	■	■	12 ÷ 54	22,9 ÷ 8,4
50-315DN	-	-	-	■	-	42 ÷ 132	90,4 ÷ 73,4	-	-	-	-
50-315C	-	-	-	-	-	-	-	■	■	18 ÷ 84	24,7 ÷ 16,8
50-315CN	-	-	-	■	-	42 ÷ 132	105 ÷ 88,7	-	-	-	-
50-315B	-	-	-	-	-	-	-	■	■	18 - 90	31,4 - 21,6
50-315BN	-	-	-	■	-	42 ÷ 144	124,3 ÷ 103,5	-	-	-	-
50-315A	-	-	-	-	-	-	-	■	■	18 - 96	37,2 - 25,1
50-315AN	-	-	-	■	-	42 ÷ 144	146,9 ÷ 125,8	-	-	-	-
65-125B1	■	-	-	-	-	30 ÷ 108	20,6 ÷ 15	-	-	-	-
65-125B	■	-	-	■	■	30 ÷ 120	20,6 ÷ 13,1	■	■	18 ÷ 60	5,1 ÷ 2,8
65-125A1	■	-	-	-	-	30 ÷ 120	25,2 ÷ 18,8	-	-	-	-
65-125A	■	-	-	■	■	30 ÷ 132	25,2 ÷ 16,8	■	■	18 ÷ 72	6,3 ÷ 3
65-160C	■	-	-	■	■	42 ÷ 144	30,6 ÷ 13,9	■	■	24 ÷ 78	7,6 ÷ 2,9
65-160B	■	-	-	■	■	42 ÷ 144	35,1 ÷ 20,4	■	■	24 ÷ 78	8,6 ÷ 3,6
65-160A1	■	-	-	-	-	42 ÷ 138	42,5 ÷ 31,7	-	-	-	-
65-160A	■	-	-	■	■	42 ÷ 144	42,5 ÷ 30,9	■	■	24 ÷ 84	9,9 ÷ 4,6
65-200C1	■	-	-	-	-	54 ÷ 132	46,1 ÷ 28,9	-	-	-	-
65-200C	■	-	-	■	■	54 ÷ 138	46,1 ÷ 26,8	■	■	27 ÷ 84	11,6 ÷ 5
65-200B	■	-	-	■	■	54 ÷ 144	53,9 ÷ 34,6	■	■	27 ÷ 84	13,1 ÷ 7
65-200A	■	-	-	■	■	54 ÷ 144	61,8 ÷ 44,4	■	■	27 ÷ 84	14,8 ÷ 9,3
65-250B	■	-	-	■	■	54 ÷ 144	80,6 ÷ 47,3	■	■	27 ÷ 84	21 ÷ 8,7
65-250A	■	-	-	■	■	54 ÷ 150	91,6 ÷ 57,9	■	■	30 ÷ 90	22,9 ÷ 8,8
65-315CM	-	-	-	-	-	-	-	■	■	27 ÷ 126	23,5 ÷ 13,9
65-315CN	-	-	-	■	-	54 ÷ 180	96,5 ÷ 80,8	-	-	-	-
65-315BM	-	-	-	-	-	-	-	■	■	27 ÷ 132	28,9 ÷ 17,2
65-315BN	-	-	-	■	-	54 ÷ 195	117,9 ÷ 96,3	-	-	-	-
65-315AM	-	-	-	-	-	-	-	■	■	27 ÷ 138	34 ÷ 18,2
65-315AN	-	-	-	■	-	54 ÷ 210	138,8 ÷ 110,4	-	-	-	-
80-160E	■	-	-	■	■	66 ÷ 168	22,9 ÷ 13,7	■	■	24 ÷ 96	5,7 ÷ 2,2
80-160D	■	-	-	■	■	66 ÷ 180	27,3 ÷ 16,4	■	■	27 ÷ 102	6,8 ÷ 2,6
80-160C1	■	-	-	-	-	66 ÷ 195	30,9 ÷ 18,4	-	-	-	-
80-160C	■	-	-	■	■	66 ÷ 195	30,9 ÷ 18,4	■	■	30 ÷ 108	7,4 ÷ 3,1
80-160B	■	-	-	■	■	66 ÷ 210	35,9 ÷ 22	■	■	33 ÷ 120	8,9 ÷ 3,5
80-160A	■	-	-	■	■	66 ÷ 225	40,5 ÷ 23,9	■	■	36 ÷ 132	9,8 ÷ 3,8
80-200B	■	-	-	■	■	72 ÷ 225	54,5 ÷ 38,5	■	■	42 ÷ 132	13,1 ÷ 7,1
80-200A	■	-	-	■	■	72 ÷ 240	61,7 ÷ 43,9	■	■	42 ÷ 144	14,7 ÷ 7,5
80-250B	-	■	■	■	■	96 ÷ 225	80 ÷ 58,8	■	■	42 ÷ 132	19,2 ÷ 11,1
80-250A	-	■	■	■	■	96 ÷ 240	92,8 ÷ 65,2	■	■	42 ÷ 144	22,9 ÷ 12,6
80-315B	-	-	-	-	-	-	-	■	■	42 ÷ 150	28,3 ÷ 19,9
80-315BN	-	-	-	■	-	78 ÷ 255	112,4 ÷ 90,8	-	-	-	-
80-315A	-	-	-	-	-	-	-	■	■	42 ÷ 168	35 ÷ 23,7
80-315AN	-	-	-	■	-	78 ÷ 255	141,4 ÷ 118,5	-	-	-	-
100-160B	■	-	-	-	-	96 ÷ 330	40,7 ÷ 25,7	-	-	-	-
100-160A	■	-	-	-	-	96 ÷ 330	45,1 ÷ 31,9	-	-	-	-
100-200D	-	-	-	■	■	108 ÷ 300	43,1 ÷ 26,6	■	■	48 ÷ 168	10,8 ÷ 4,8
100-200C	-	-	-	■	■	108 ÷ 330	48,4 ÷ 28,1	■	■	48 ÷ 168	12 ÷ 6,3
100-200B	-	■	■	■	■	108 ÷ 330	56,8 ÷ 39,7	■	■	48 ÷ 180	13,6 ÷ 7,8
100-200A	-	■	■	■	■	108 ÷ 360	62,2 ÷ 42,5	■	■	48 ÷ 192	15,4 ÷ 9,1
100-250E	-	-	-	-	-	-	-	■	■	60 ÷ 180	16,9 ÷ 11,4
100-250D	-	-	-	-	-	-	-	■	■	60 ÷ 192	19,6 ÷ 12,7



TYPE	2 POLES							4 POLES			
	CM	CMG	CMGX	CA	CAT CAX CATX	Flow rate	Head	4CA 4CAT	4CAX 4CATX	Flow rate	Head
						m ³ /h	m			m ³ /h	m
100-250C	-	■	■	■	■	120 ÷ 300	73,2 ÷ 61	-	-	-	-
100-250B	-	■	■	■	■	120 ÷ 330	83,7 ÷ 67,6	-	-	-	-
100-250A	-	■	■	■	■	120 ÷ 360	93,9 ÷ 73,2	■	■	60 ÷ 204	22,3 ÷ 13,8
100-315B	-	-	-	-	-	-	-	■	■	72 ÷ 216	31,4 ÷ 17,9
100-315A	-	-	-	-	-	-	-	■	■	72 ÷ 216	36,5 ÷ 23,1
100-400C	-	-	-	-	-	-	-	■	■	84 ÷ 228	40,6 ÷ 25,8
100-400B	-	-	-	-	-	-	-	■	■	84 ÷ 240	48,7 ÷ 31,6
100-400A	-	-	-	-	-	-	-	■	■	84 ÷ 252	56 ÷ 36,7
125-250B	-	-	-	-	-	-	-	■	■	102 ÷ 252	20,2 ÷ 11,1
125-250A	-	-	-	-	-	-	-	■	■	102 ÷ 276	24 ÷ 14,7
125-315C	-	-	-	-	-	-	-	■	■	120 ÷ 348	25,8 ÷ 15,7
125-315B	-	-	-	-	-	-	-	■	■	120 ÷ 372	33 ÷ 22,2
125-315A	-	-	-	-	-	-	-	■	■	120 ÷ 372	39,6 ÷ 28,2
125-400C	-	-	-	-	-	-	-	■	■	120 ÷ 372	47,6 ÷ 33,8
125-400B	-	-	-	-	-	-	-	■	■	120 ÷ 396	54,5 ÷ 39,1
125-400A	-	-	-	-	-	-	-	■	■	120 ÷ 396	59,5 ÷ 45
150-315D	-	-	-	-	-	-	-	■	■	144 ÷ 444	28,3 ÷ 19,6
150-315C	-	-	-	-	-	-	-	■	■	144 ÷ 492	32,2 ÷ 21,8
150-315B	-	-	-	-	-	-	-	■	■	144 ÷ 540	36,3 ÷ 23,6
150-315A	-	-	-	-	-	-	-	■	■	144 ÷ 564	41 ÷ 27,2
150-400C	-	-	-	-	-	-	-	■	■	168 ÷ 564	47,8 ÷ 28,7
150-400B	-	-	-	-	-	-	-	■	■	168 ÷ 588	54,4 ÷ 34,3
150-400A	-	-	-	-	-	-	-	■	■	168 ÷ 612	60,3 ÷ 39,8
Not envisaged in the EN 733 standard											
200-315D	-	-	-	-	-	-	-	■	■	200 ÷ 800	21,7 ÷ 12,5
200-315C	-	-	-	-	-	-	-	■	■	200 ÷ 850	26,6 ÷ 14,6
200-315B	-	-	-	-	-	-	-	■	■	200 ÷ 900	33,4 ÷ 16,7
200-315A	-	-	-	-	-	-	-	■	■	200 ÷ 900	35,9 ÷ 19,8
200-400C	-	-	-	-	-	-	-	■	■	200 ÷ 800	44,1 ÷ 31,5
200-400B	-	-	-	-	-	-	-	■	■	200 ÷ 850	50,8 ÷ 36,6
200-400A	-	-	-	-	-	-	-	■	■	200 ÷ 900	58,5 ÷ 44
250-315C	-	-	-	-	-	-	-	■	■	250 ÷ 1100	25,5 ÷ 16,8
250-315B	-	-	-	-	-	-	-	■	■	250 ÷ 1170	33 ÷ 19
250-315A	-	-	-	-	-	-	-	■	■	250 ÷ 1200	35 ÷ 20
250-400D	-	-	-	-	-	-	-	■	■	250 ÷ 1300	39,9 ÷ 24,3
250-400C	-	-	-	-	-	-	-	■	■	250 ÷ 1400	45,8 ÷ 27,4
250-400B	-	-	-	-	-	-	-	■	■	250 ÷ 1500	51,7 ÷ 30,3
250-400A	-	-	-	-	-	-	-	■	■	250 ÷ 1600	57,4 ÷ 31,7



CMG Series

Models list and materials

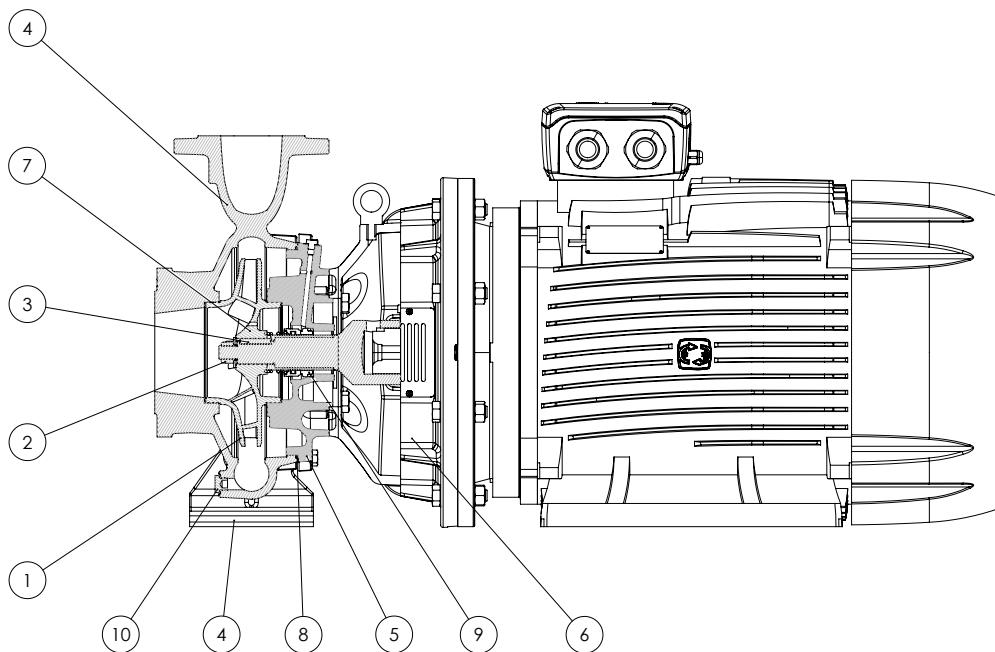

POS. N.	DENOMINATION	VERSION	MATERIAL	REFERENCE STANDARDS	
				EUROPE	USA
1	Impeller	Standard	Cast iron G20	GJL-200 (JL1030)	ASTM Class 30
		B	Bronze	CuSn10-C (CC480K)	UNS C90700
		X	Stainless steel	X5CrNiMo17-12-2/ 1.4401	AISI 316
2	Impeller lock nut and washer		Stainless steel	X5CrNiMo17-12-2/ 1.4401	AISI 316
3	Impeller key		Stainless steel	X5CrNiMo17-12-2/ 1.4401	AISI 316
4	Volute casing	Standard	Cast iron G25	GJL-250 (JL1040)	ASTM Class 35
		X	Stainless steel	X5CrNiMo17-12-2/ 1.4401	AISI 316
5	Casing cover	Standard	Cast iron G20	GJL-200 (JL1030)	ASTM Class 30
		X	Stainless steel	X5CrNiMo17-12-2/ 1.4401	AISI 316
6	Motor bracket		Cast iron G20	GJL-200 (JL1030)	ASTM Class 30
7	Stub shaft		Stainless steel	X5CrNiMo17-12-2/ 1.4401	AISI 316
8	O-ring	Standard	NBR		
		E	EPDM		
		V	FKM		
9	Mechanical seal		(Search for the material in the mechanical seal table)		
10	Fill and drain plugs	Fill and drain plugs	Brass	CU ZN 40 PB2 UNI 5705/65	C37700

CMG-CMGX ~ 2900 rpm

Centrifugal Flanged
EN 733

TYPE - 50 Hz	P2	Motor Size	Q (m³/h - l/min)																		
			0	96	108	120	132	138	144	156	168	180	195	210	225	240	255	270	300	330	360
			0	1600	1800	2000	2200	2300	2400	2600	2800	3000	3250	3500	3750	4000	4250	4500	5000	5500	6000
kW		H (m) <i>pump input power (kW)</i>																			
80-250B	45	225M	77,2	80,0	79,0	77,5	75,3	74,2	73,1	71,0	69,0	67,0	64,5	61,8	58,8						
			14,01	30,93	32,60	34,34	36,13	37,02	37,86	39,38	40,78	42,10	43,60	44,94	46,15						
80-250A	55	250M	90,0	92,8	91,1	89,3	87,4	86,4	85,4	83,1	80,7	78,5	75,7	72,4	68,8	65,2					
			16,74	36,56	38,57	40,54	42,46	43,39	44,31	46,12	47,81	49,29	50,92	52,59	54,18	55,50					
100-200B	45	225M	56,1		56,8	56,5	56,1	55,9	55,6	55,1	54,5	53,9	53,1	52,2	51,4	50,4	49,0	47,5	43,8	39,7	
			21,75		28,84	29,78	30,74	31,24	31,75	32,81	33,89	35,04	36,50	37,82	38,89	39,85	40,77	41,60	42,92	43,82	
100-200A	55	250M	61,1		62,2	61,8	61,5	61,2	61,0	60,5	59,9	59,5	58,9	58,3	57,4	56,4	55,2	53,8	50,6	46,8	
			24,57		33,04	34,07	35,11	35,64	36,18	37,28	38,39	39,49	40,86	42,23	43,60	44,97	46,20	47,28	49,05	50,53	51,62
100-250C	55	250M	71,9			73,2	73,1	73,0	72,9	72,6	72,2	71,8	71,1	70,3	69,3	67,9	66,4	64,7	61,0		
	75	280S	24,75			40,12	41,93	42,84	43,70	45,28	46,77	48,21	49,94	51,65	53,38	55,05	56,66	58,19	60,99		
100-250B	75	280S	83,6			83,7	83,5	83,4	83,2	82,9	82,5	82,1	81,4	80,8	80,0	79,0	77,9	76,4	72,0		
			29,69			47,10	49,06	50,04	51,01	52,92	54,76	56,47	58,46	60,26	61,86	63,49	65,17	66,93	70,91	73,78	
100-250A	90	280M	93,5			93,9	93,7	93,5	93,4	92,9	92,4	91,8	90,9	89,9	88,8	87,4	85,7	84,0	80,4		
			32,71			51,99	54,14	55,23	56,31	58,48	60,60	62,57	64,88	66,97	68,84	70,81	72,81	74,73	78,17	81,33	85,53



CM-CMG-CMGX-CA-CAX ~ EN 733

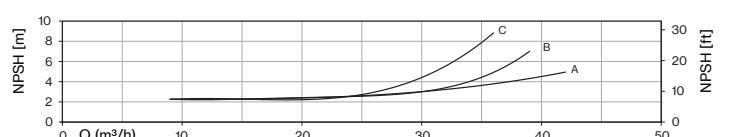
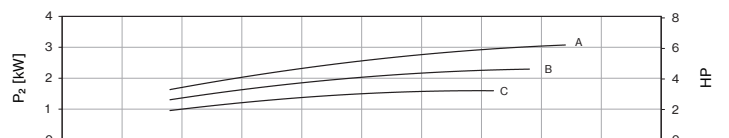
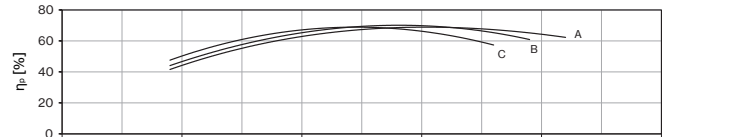
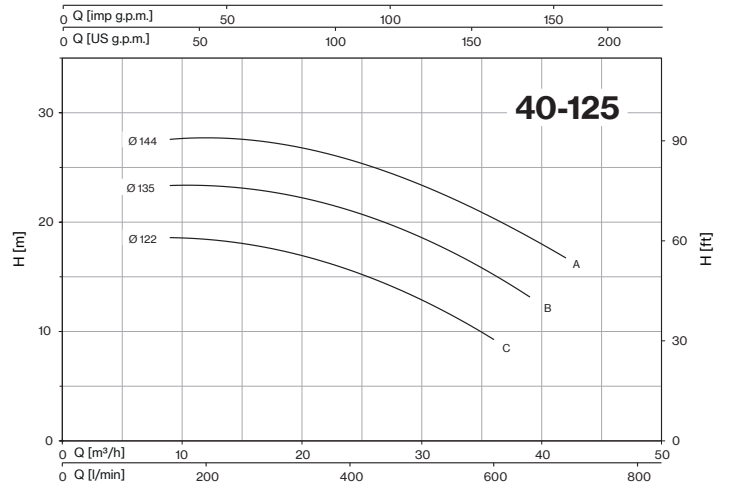
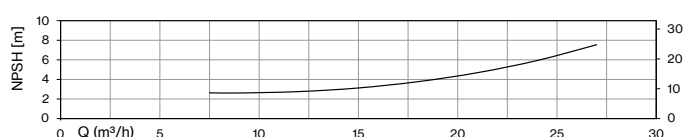
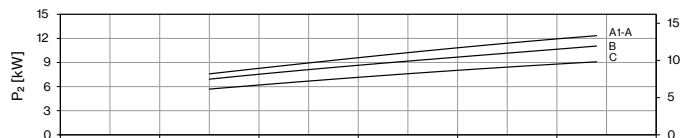
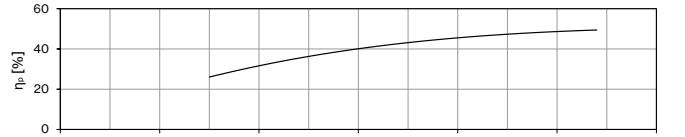
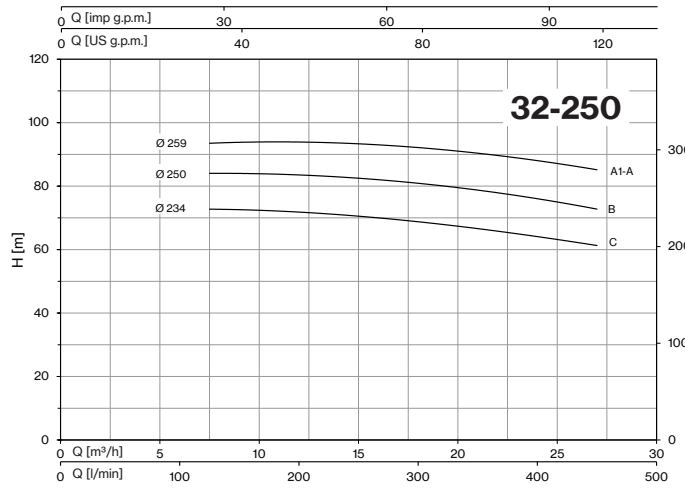
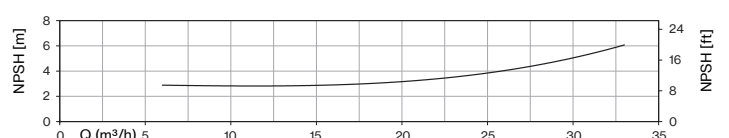
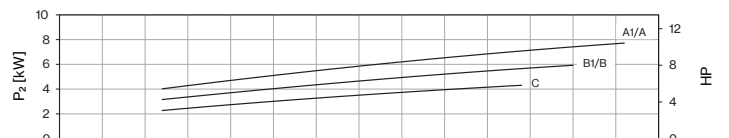
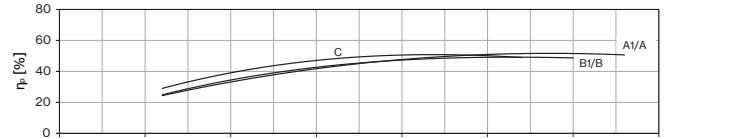
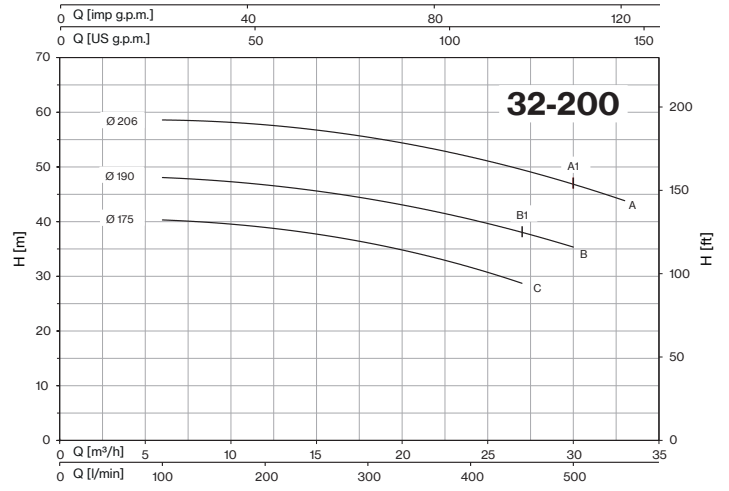
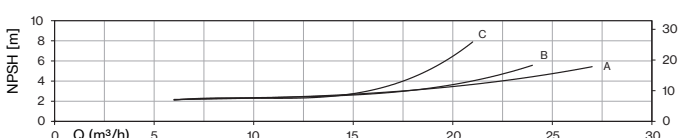
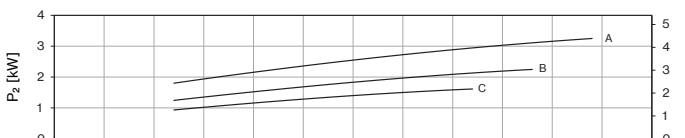
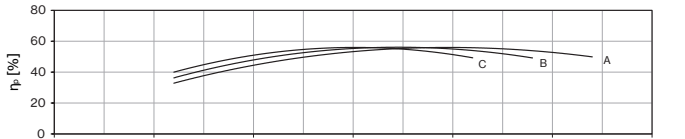
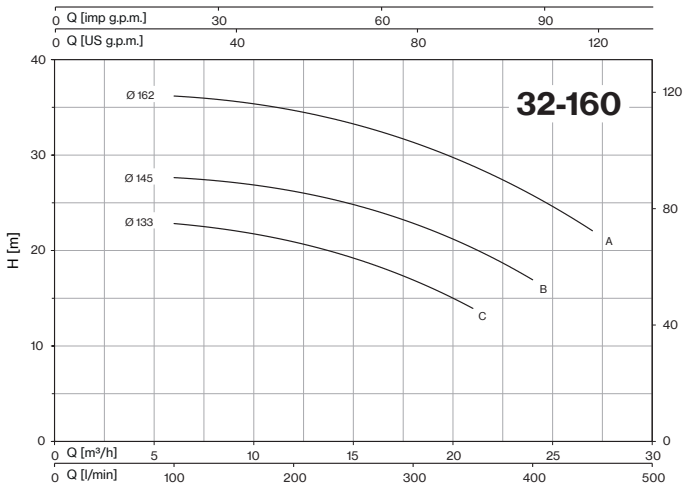

CM-CMG-CMGX-CA-CAX ~ EN 733

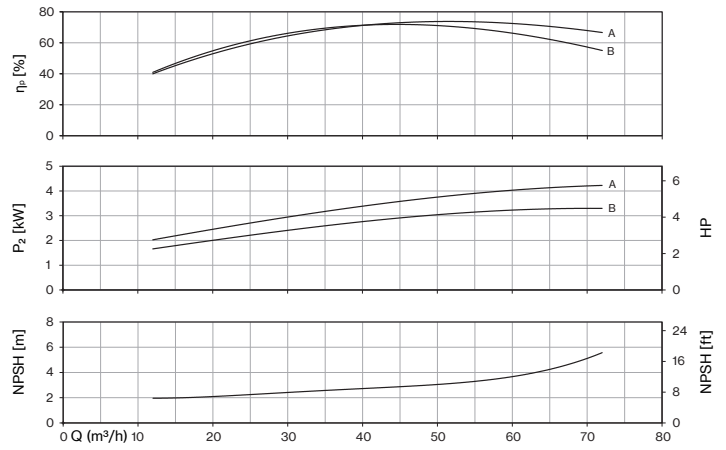
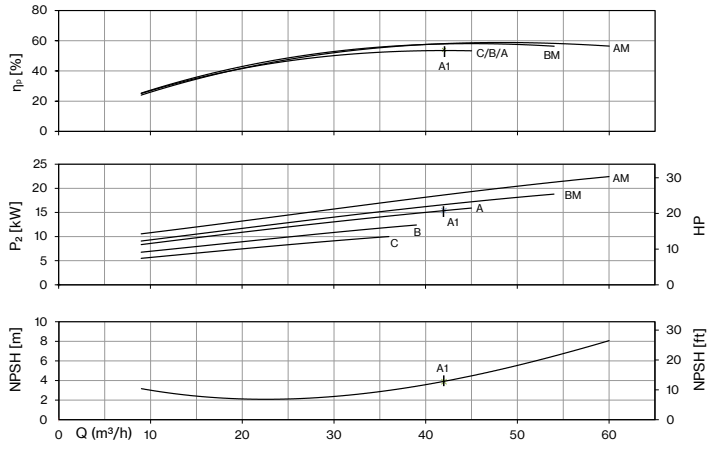
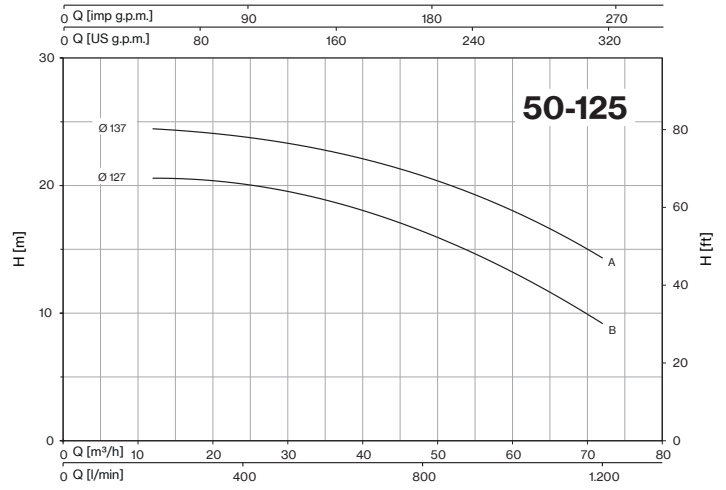
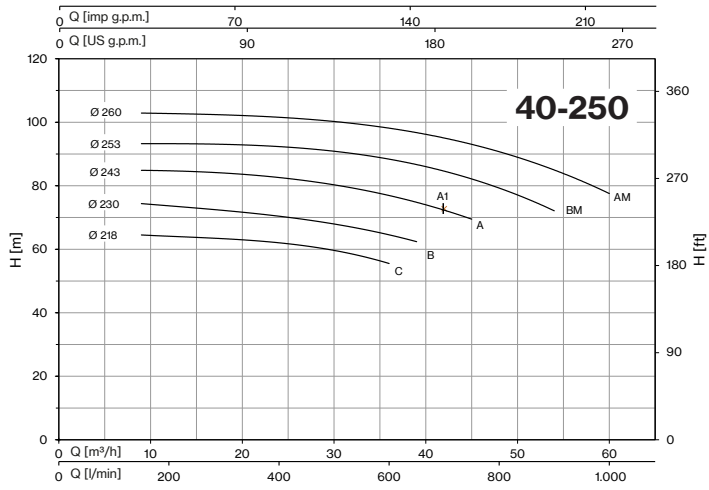
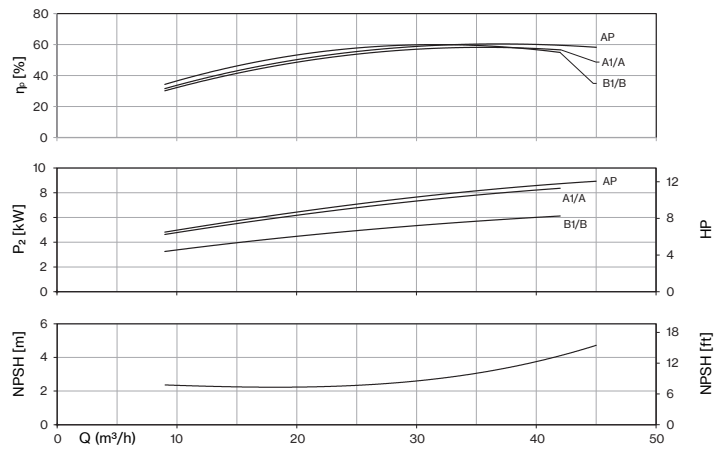
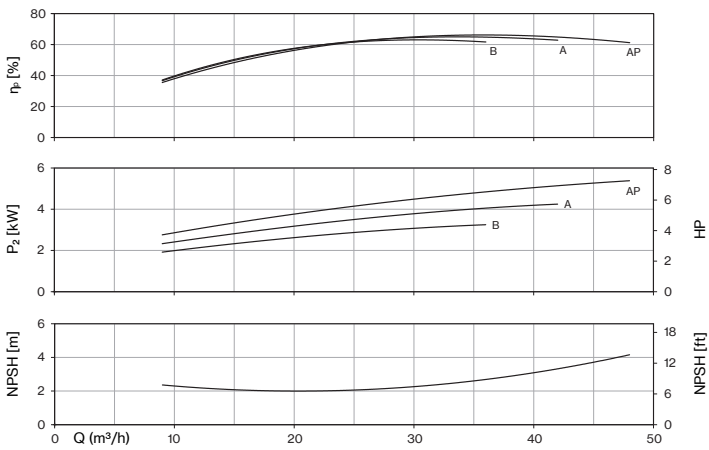
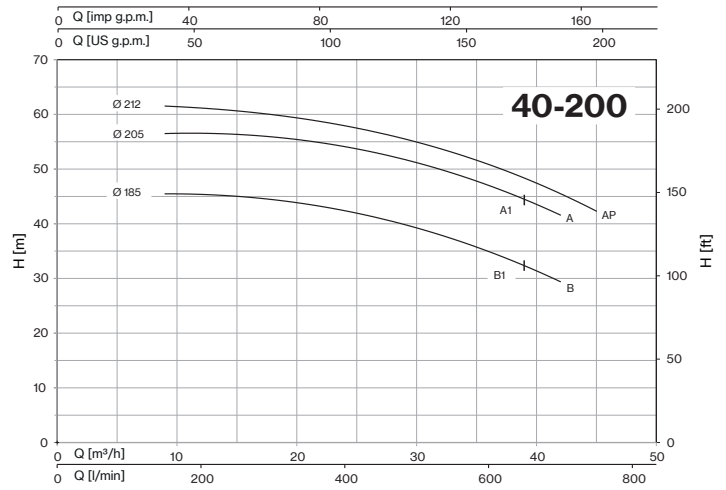
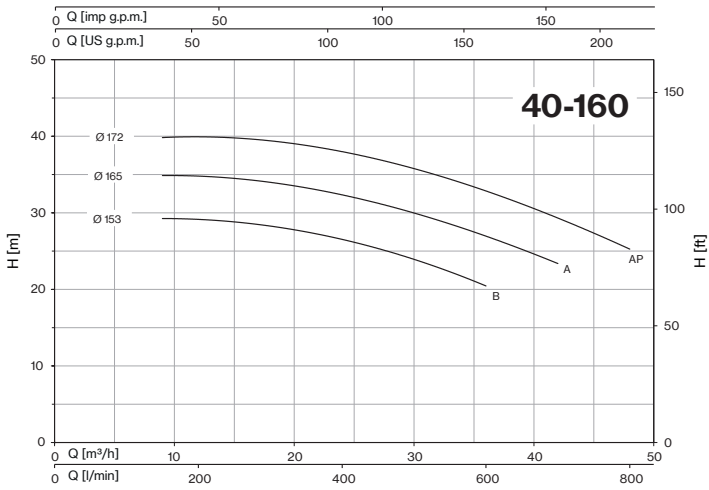

CM-CMG-CMGX-CA-CAX ~ EN 733

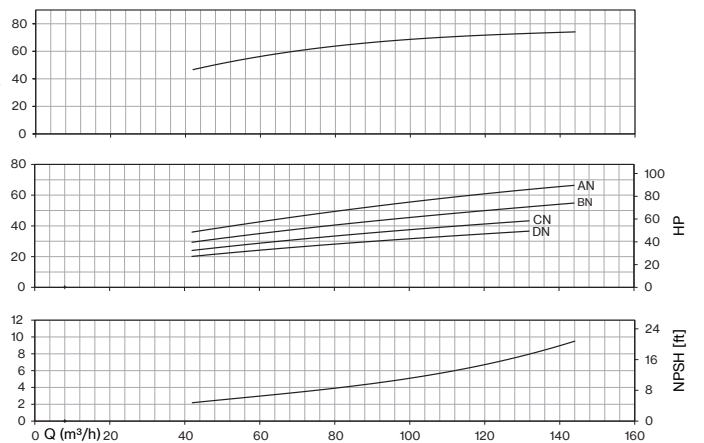
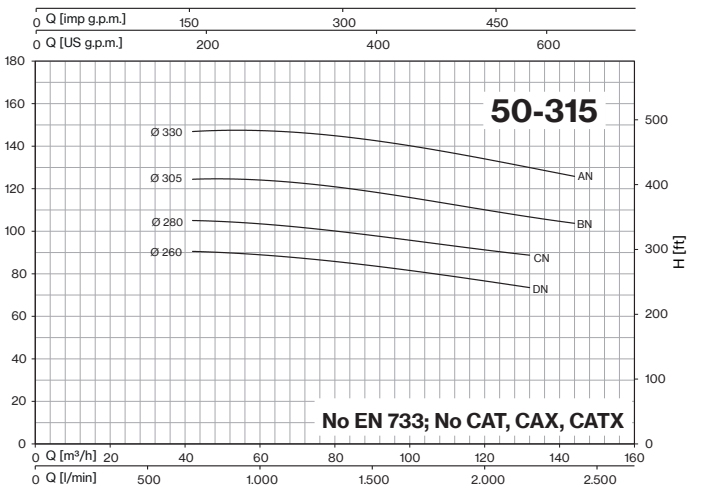
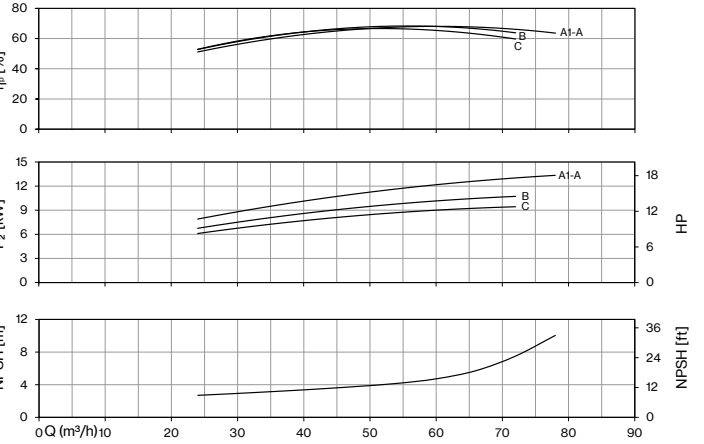
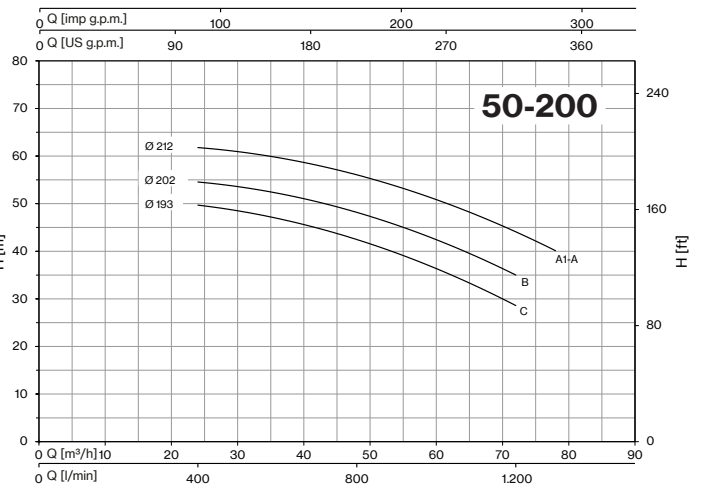
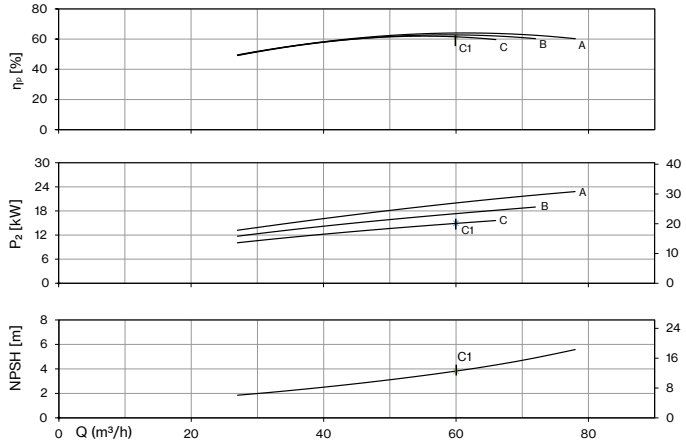
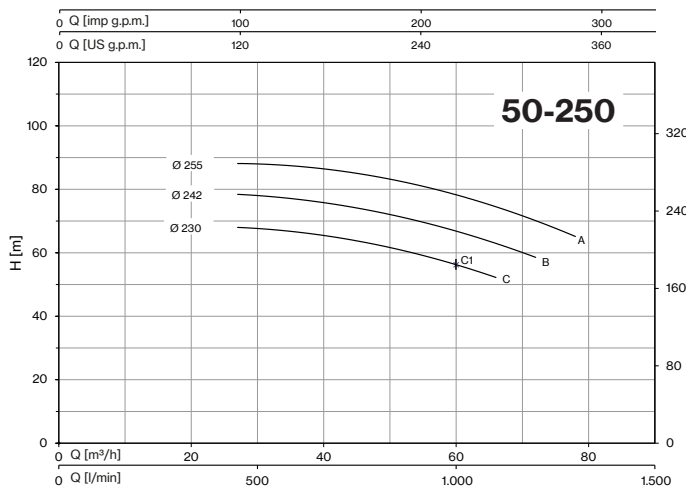
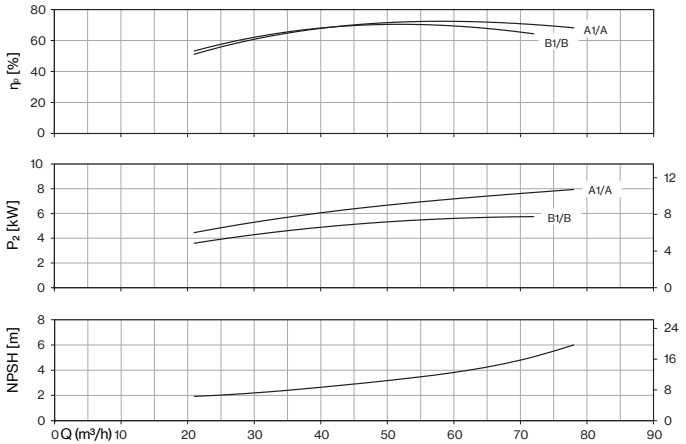
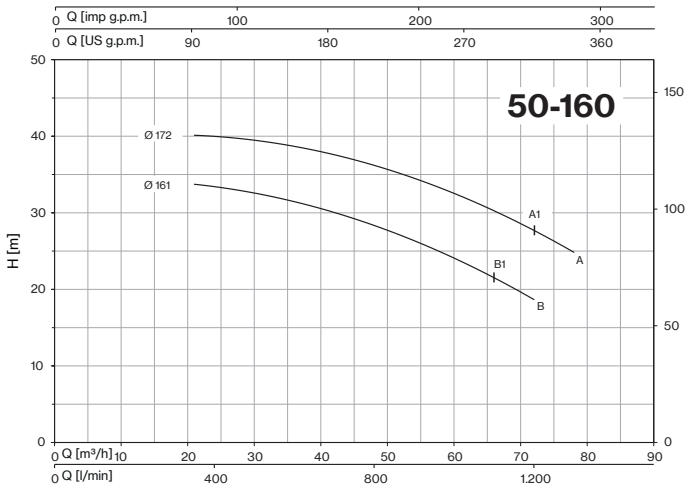

No EN 733; No CAT, CAX, CATX



CM-CMG-CMGX-CA-CAX ~ EN 733

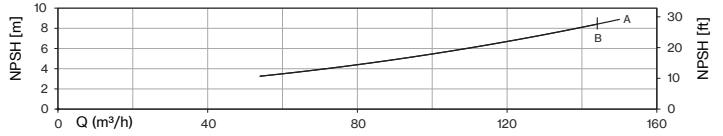
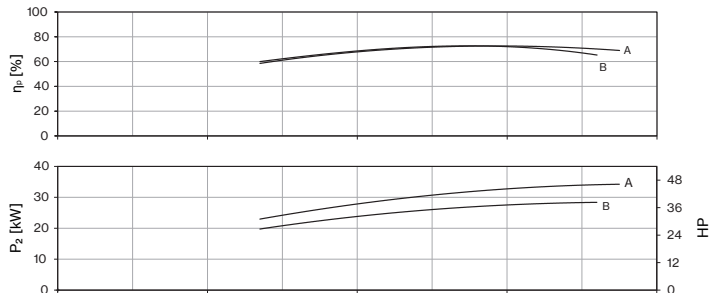
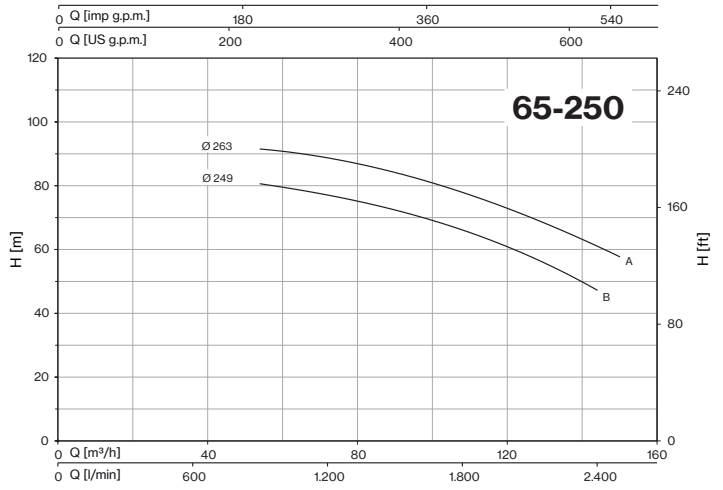
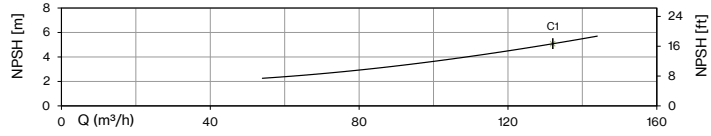
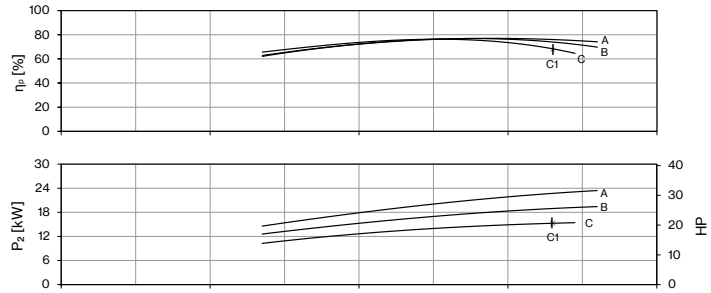
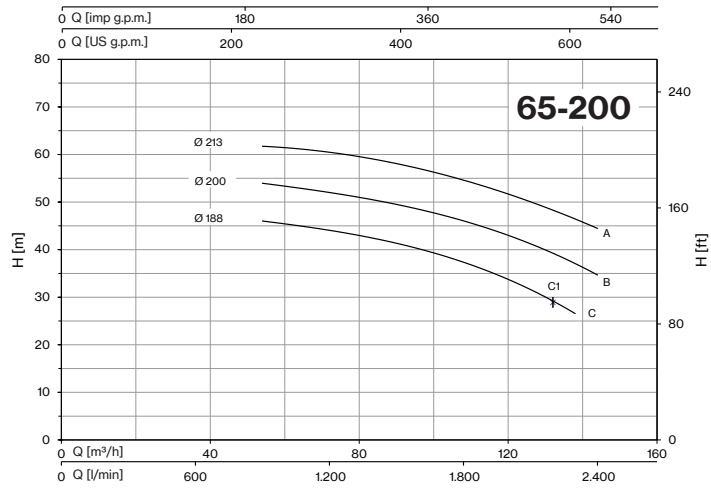
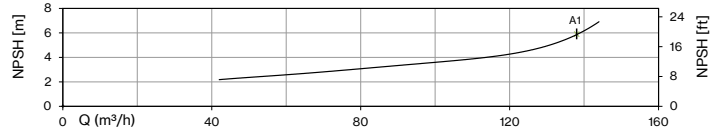
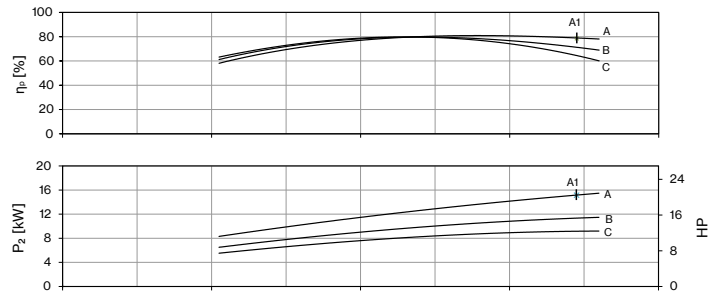
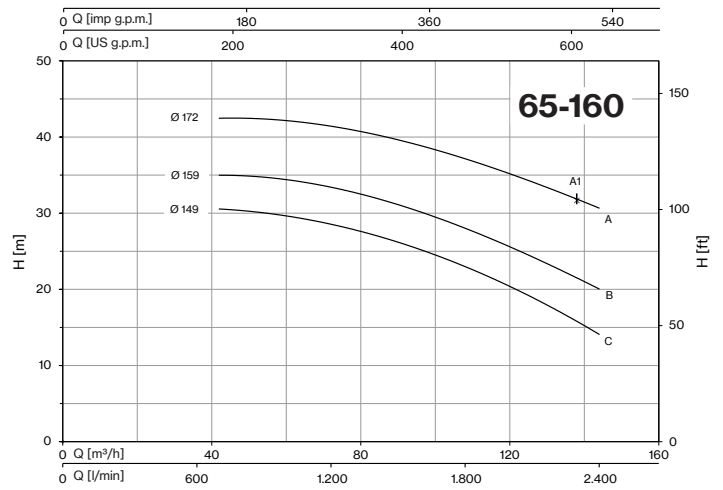
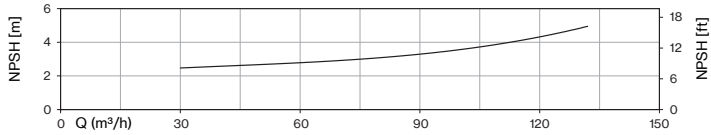
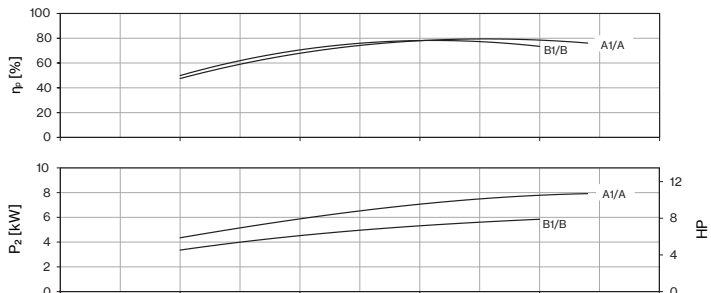
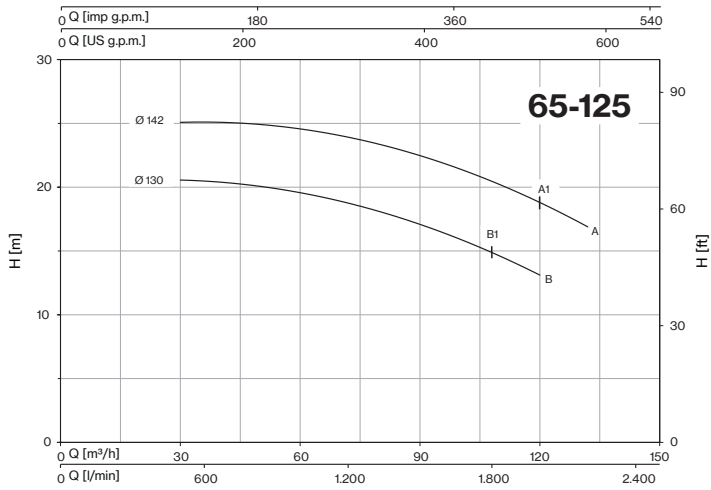

CM-CMG-CMGX-CA-CAX ~ EN 733

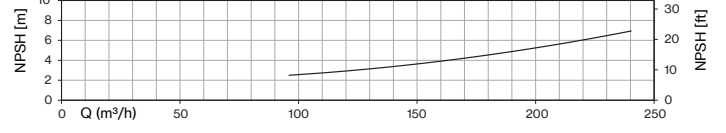
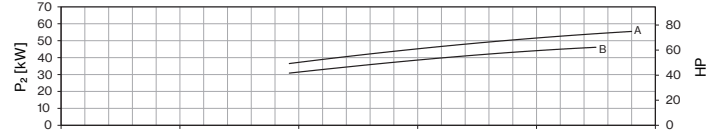
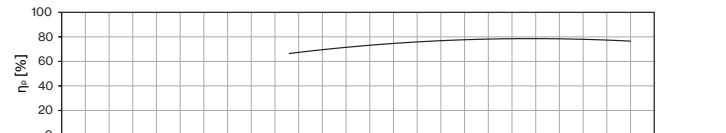
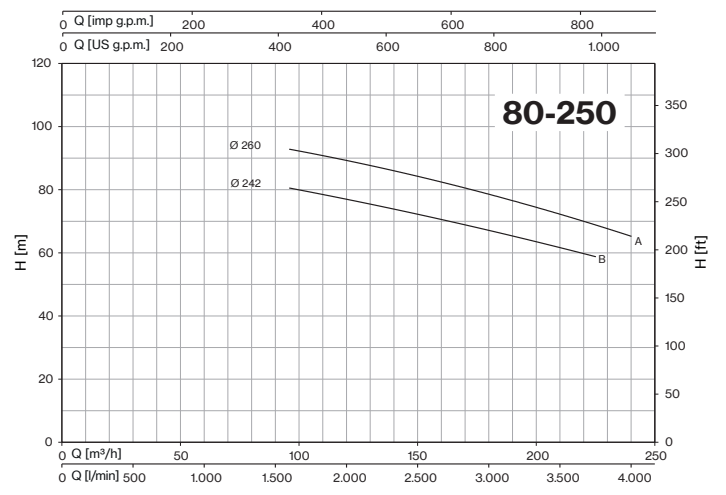
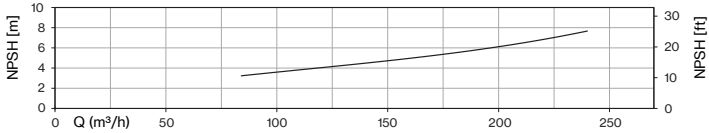
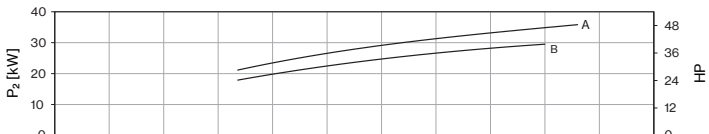
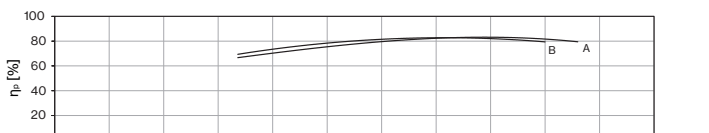
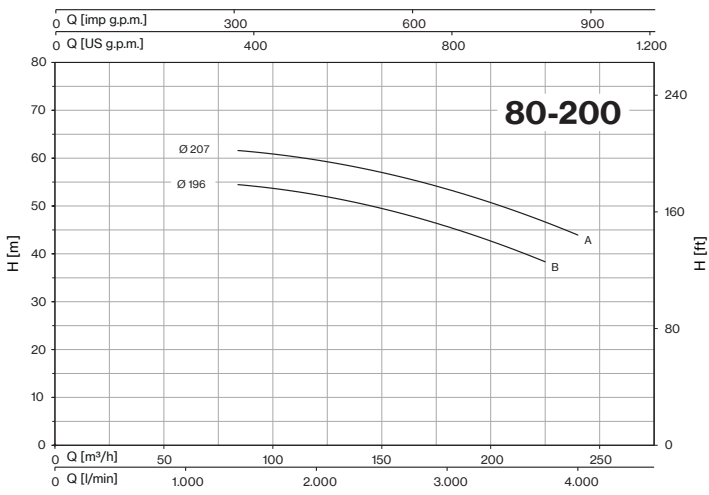
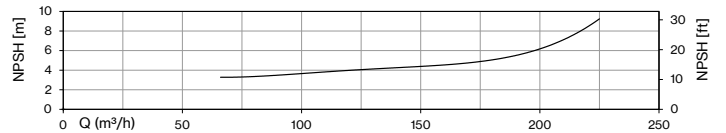
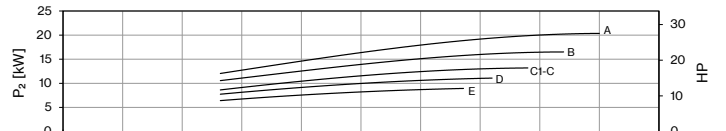
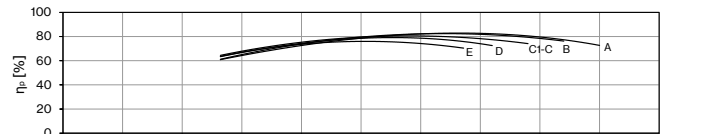
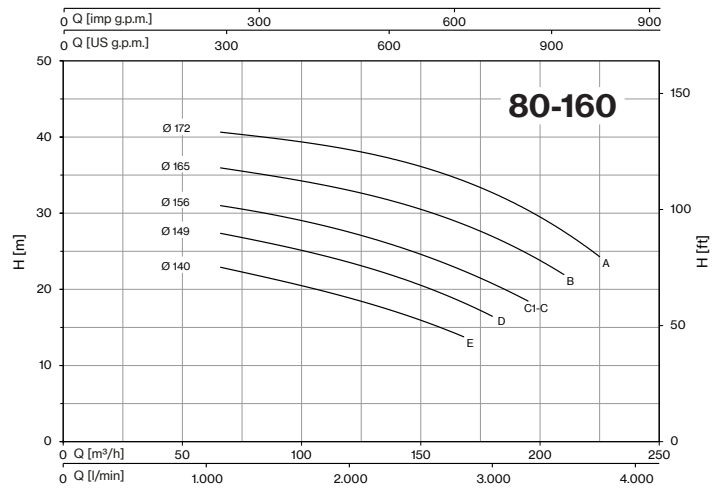
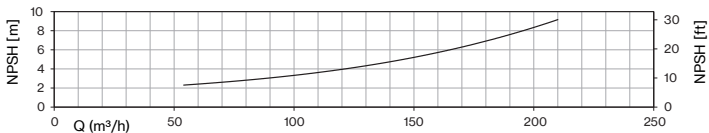
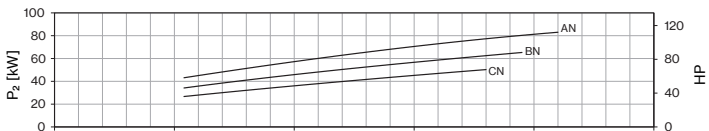
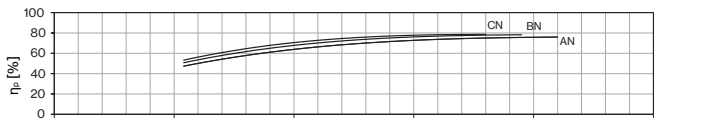
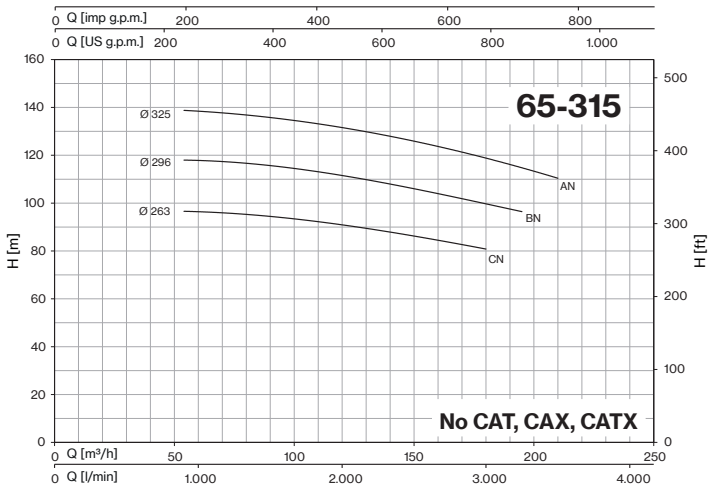

CM-CMG-CMGX-CA-CAX ~ EN 733

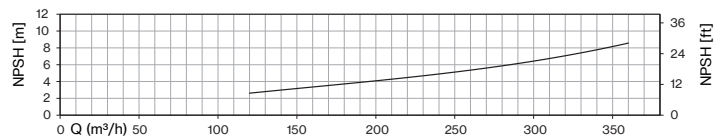
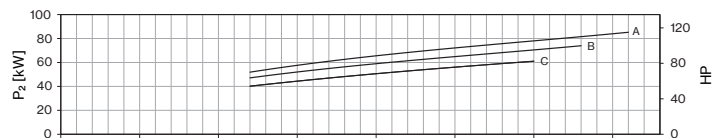
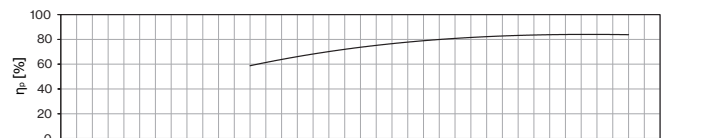
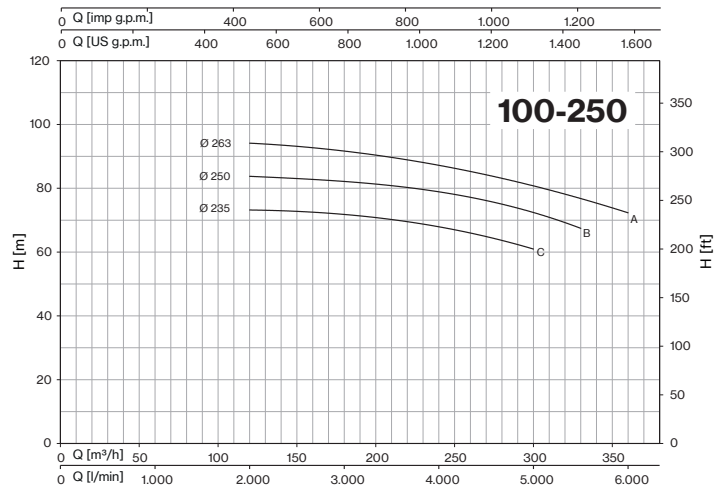
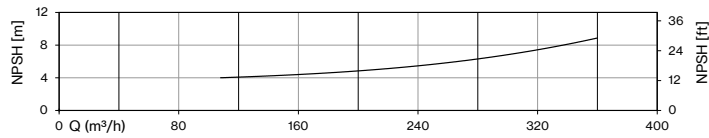
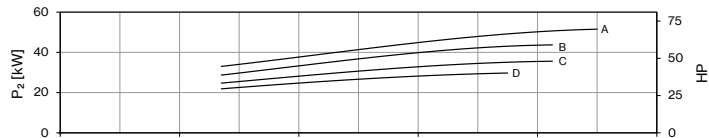
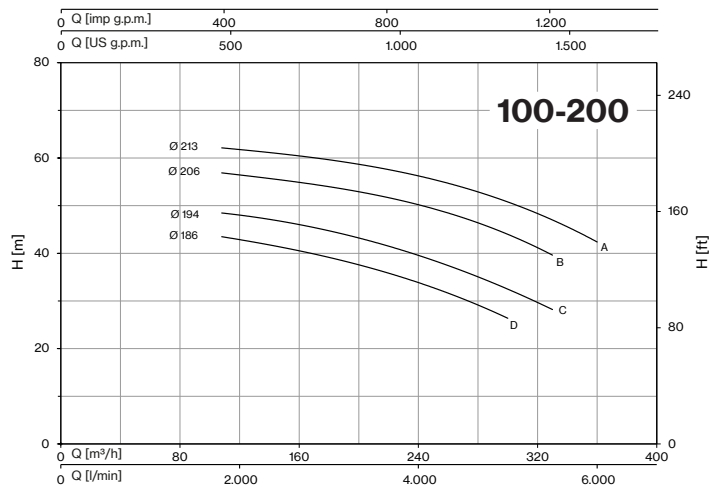
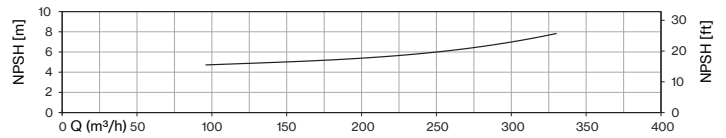
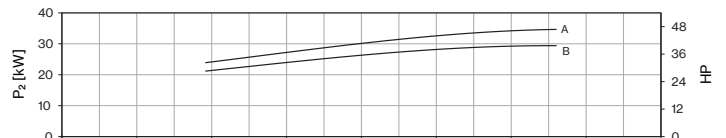
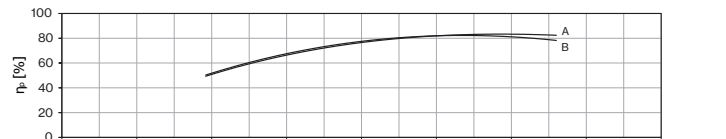
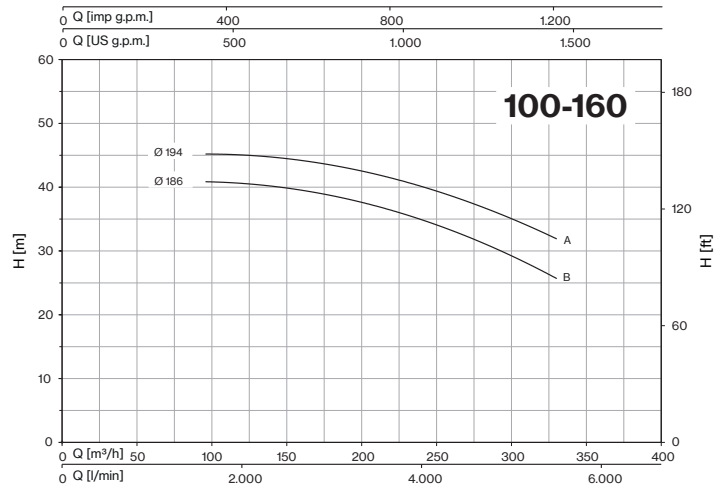
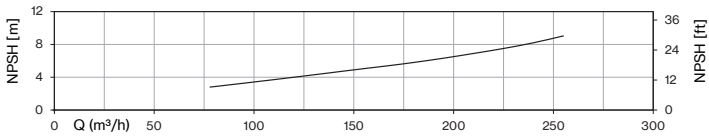
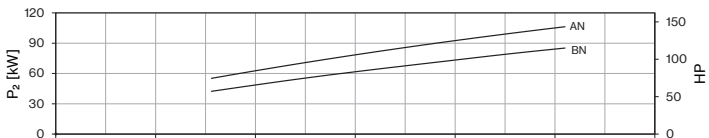
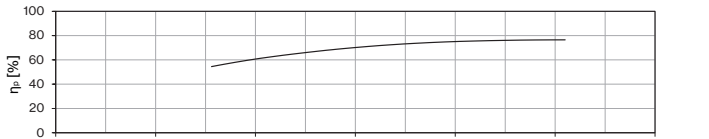
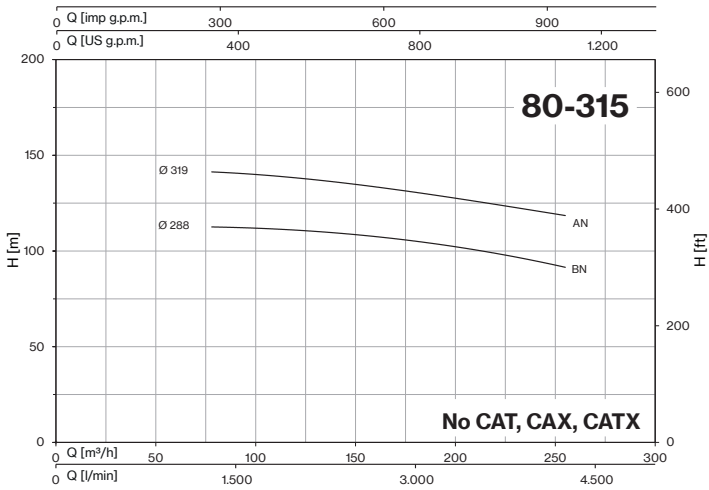

CMG-CMGX ~ EN 733

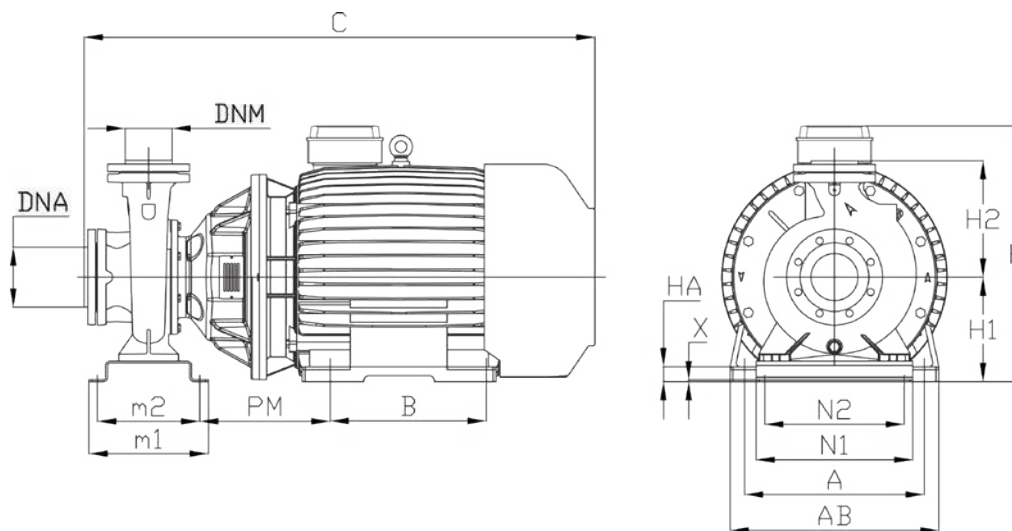

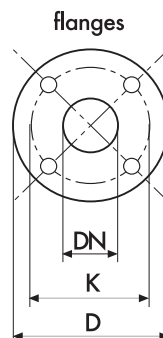

TYPE	DIMENSIONS (mm)															Kg
	m1	m2	N2	N1	H1	H2	H	A	AB	B	PM	C	HA	DNA	DNM	
80-250B	200	120	315	406	225	317	550	356	435	311	356	1130	28	100	80	418
80-250A	320	280	360	420	280	317	650	406	485	349	325	1240	58			505
100-200B	200	120	280	360	225	321	550	356	435	311	356	1130	28	125	100	417
100-200A	320	280	360	420	280	321	650	406	485	349	325	1240	60			505
100-250C	320	280	360	420	280	321	675	406	485	349	325	1315	60			516
100-250B	320	280	360	420	280	321	675	457	545	368	347	1315	35			645
100-250A	320	280	360	420	280	321	675	457	545	419	347	1370	35		680	

DIMENSIONS (mm)				
DN	D	K	holes	
			n°	Ø
80	200	160	8	18
100	220	180	8	18
125	250	210	8	18



CMG Serie-Mechanical seal and bearings

MECHANICAL SEAL	PUMP MODEL	SHAFT Ø		STANDARD MATERIAL	OPTIONAL			
					E	V	2E	2V
	80-250, 100-200, 100-250	45mm	Rotating face Stationary face Elastomer	CrNi-steel Graphite NBR	CrNi-steel Graphite EPDM	CrNi-steel Graphite FKM	SiC SiC EPDM	SiC SiC FKM

MOTOR BEARINGS	PUMP MODEL	TYPE	
	80-250, 100-200	6313-ZZ C3	6313-ZZ C3
	80-250, 100-200, 100-250	6314-ZZ C3	6314-ZZ C3